

## Montageanleitung H0 Ringlockschruppen mit Türschließvorrichtung, sechsständig

### Mounting instruction

### H0 Roundhouse with door lock mechanism, six track

(DE)

Bitte legen Sie die Einzelteile nach Buchstabengruppen zusammen und beginnen Sie dann entsprechend der Zeichnungen mit dem Zusammenbau.

(EN)

Arrange the individual parts by letter groups, and then begin assembling in accordance with the drawings.

1. Inhalt	1	1. Contents	1
2. Montage	2	2. Mounting	2

#### 1. Inhalt/Contents Dekopapier: 135557

Spr.-Nr.	Teile-Nr.	Stück	Spr.-Nr.	Teile-Nr.	Stück	Spr.-Nr.	Teile-Nr.	Stück	Spr.-Nr.	Teile-Nr.	Stück	Spr.-Nr.	Teile-Nr.	Stück
10784	2	1	11087	23	1	11120	8	6	19159	19120	1	25763	25754	1
	2a	1					81	4		19121	3		25755	1
	2b	1	11088	24	1					19122	1		25756	1
	2c	1		25	1	11137	19173	1		19123	1		25757	1
	19201	1		26	1		19174	6		19124	1		25758	1
				27	1		19175	6		19125	1		25759	1
10709	0011	2		28	1		19176	6		19126	1		25760	1
	0012	2					19177	6		19127	1		25761	1
	0106	2	12292	29	1		19178	1		19128	1		25762	1
				30	1		19179	8		19129	1		54771	1
10722	31	1					19180	1		19156	1			
	32	1	11044	1	2		19181	1		19157	1	57630	57626	6
	33	1		2	2		19182	8		20971	1		57627	6
	34	1		3	2		20972	1					57628	6
	19117	1		4	3		20973	1	19598	19107	6		57629	6
							20974	1		19108	2			
10732	0223	1	11122	4	6		20975	1		19109	5		Zugstange	138646
				5	4								Drawbar	
11024	2	4				11139	0273	6	19164	19160	4			
	3	2	11123	14	2		0274	6		19161	1			
				15	2					19162	6		Türschließfeder	138066
11028	11	6				11027	19090	6		19163	6		Door closing spring	6
	12	6	11124	11124	6		19091	6						
							15827	6	20962	11079	10			
11026	6	4	11126	0024	6		15828	6		20956	1			
	7	4		0018	6					20957	1		Farbtablette	138502
	19089	4		0272	12	11121	1	6		20958	1		Colour tablet	1
										20959	1			
11080	11080	2	11128	20	2	11127	019	6		20960	1			
				21	2		021	6		20961	1			
11032	0023	16		22	2	11125	16	6	20967	20963	1			
	0023/1	4		0264	1		17	6		20964	1			
11037	11037	1	11129	0246	12		18	6		20965	1			
							19	6		20966	1			
11035	11035	6	11135	11135	1	10824	10824	36						
11095	0263	14	11136	11136	2									
11036	0017	12	11083	0265	6									

(DE)

Wir verwenden den recyclefähigen Kunststoff Polystyrol.

Wir gratulieren Ihnen zum Erwerb dieses hochwertigen Vollmer-Bausatzes. Die hohe Passgenauigkeit unserer Bausätze wird Ihnen viel Freude bereiten.

Diverse Kleber für die Bausätze finden Sie im Vollmer Sortiment.

Änderungen vorbehalten.

Keine Haftung für Druckfehler und Irrtümer.

(EN)

We use recyclable polystyrene.

Congratulations on your purchase of this Vollmer product. Our high quality kits will bring you much joy.

You will find various glues for the kits in the Vollmer product range.

Subject to change without prior notice.

No liability for mistakes and printing errors.

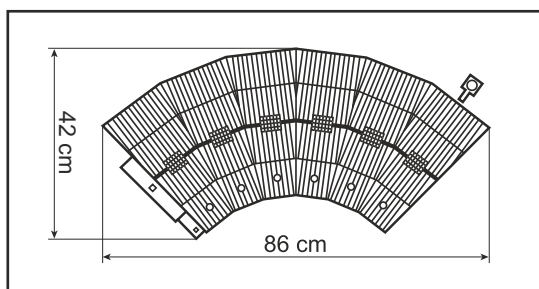

Link zum Montage Video  
Link to assembly video

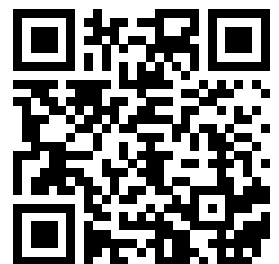

[https://www.youtube.com/watch?v=Q14\\_daqlLic](https://www.youtube.com/watch?v=Q14_daqlLic)

## 2. Montage Mounting

**(A)** 6x

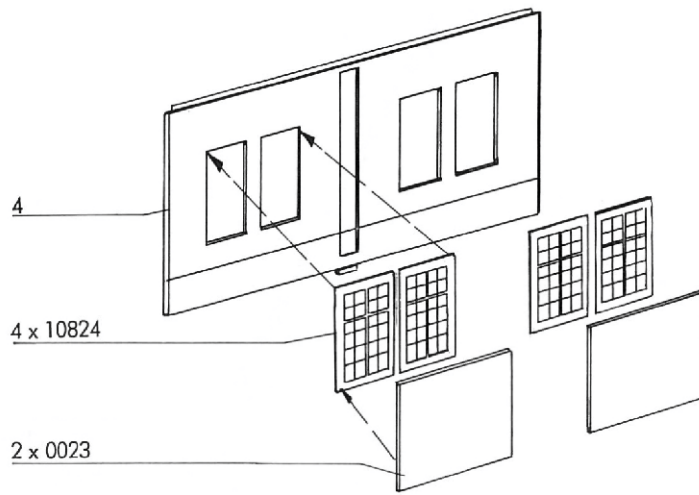

### Aufbauvariante 1 Alternative construction 1

**(B)** 6x

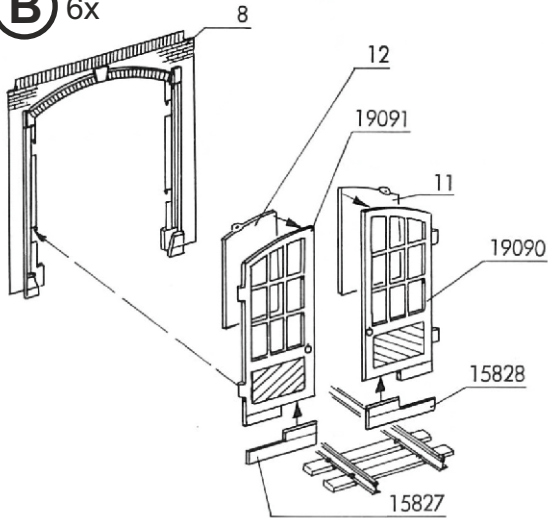

#### Für Modellgleise. For model tracks.

Märklin-K, Fleischmann Modell Gleis, Roco LINE, Hornby, Piko A-Gleis, Tillig Standard, Tillig Elite, Bemo Standard Gleis, Bemo C70, Mehano Hobby Gleis, Peco Setrack, Peco Streamline, Peco Streamline 83, Peco Finescale, Kato Unitrack, Shinohara Code 70, Shinohara Code 83, JHM STS.

### Aufbauvariante 2 Alternative construction 2

#### Für Bettungsgleise. For road bed track.

Märklin C-Gleis, Kato Unitrack H0, Roco LINE, Roco geoLINE, Tillig Elite H0, Trix C-Gleis, Peco Finescale H0, Fleischmann Profi-Gleis, Bemo Standard Gleis, Bemo C70 Schmalspur.

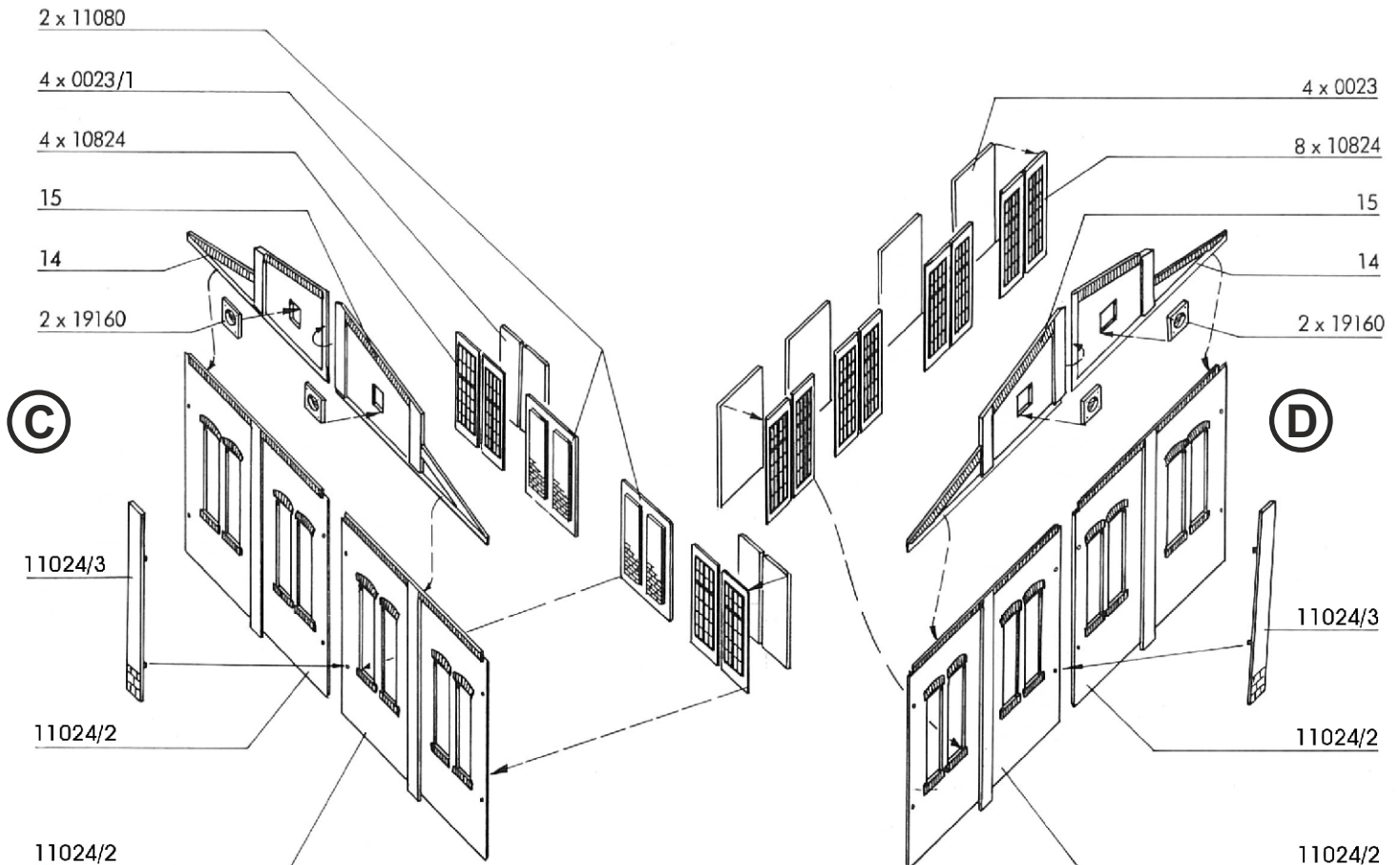
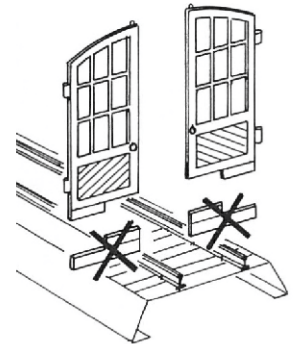

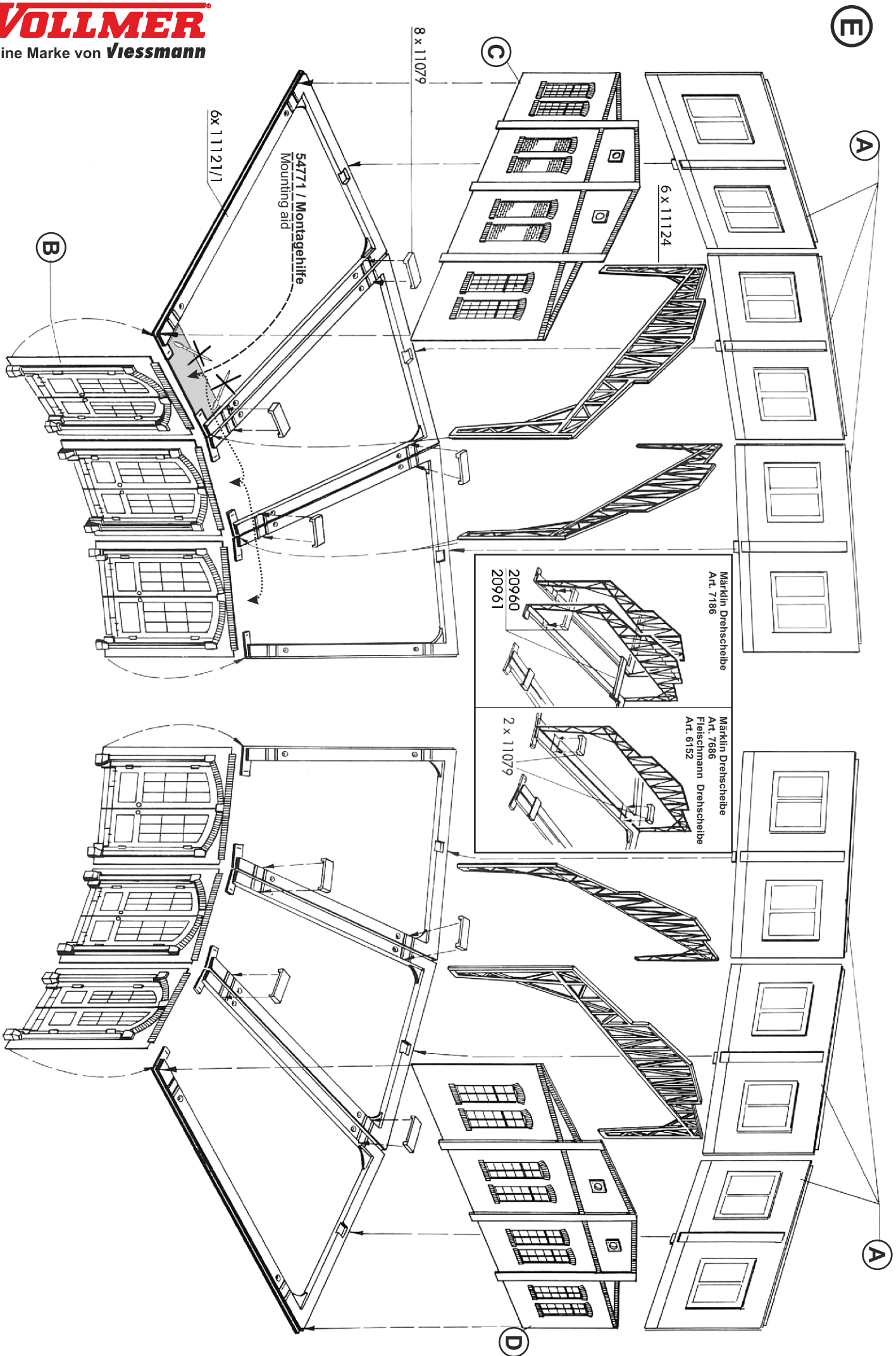

F

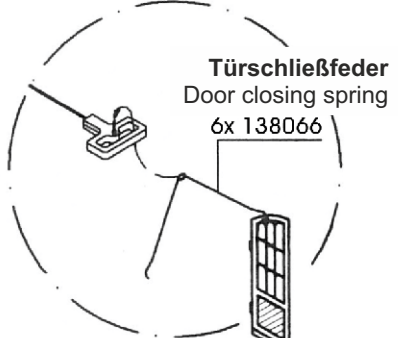
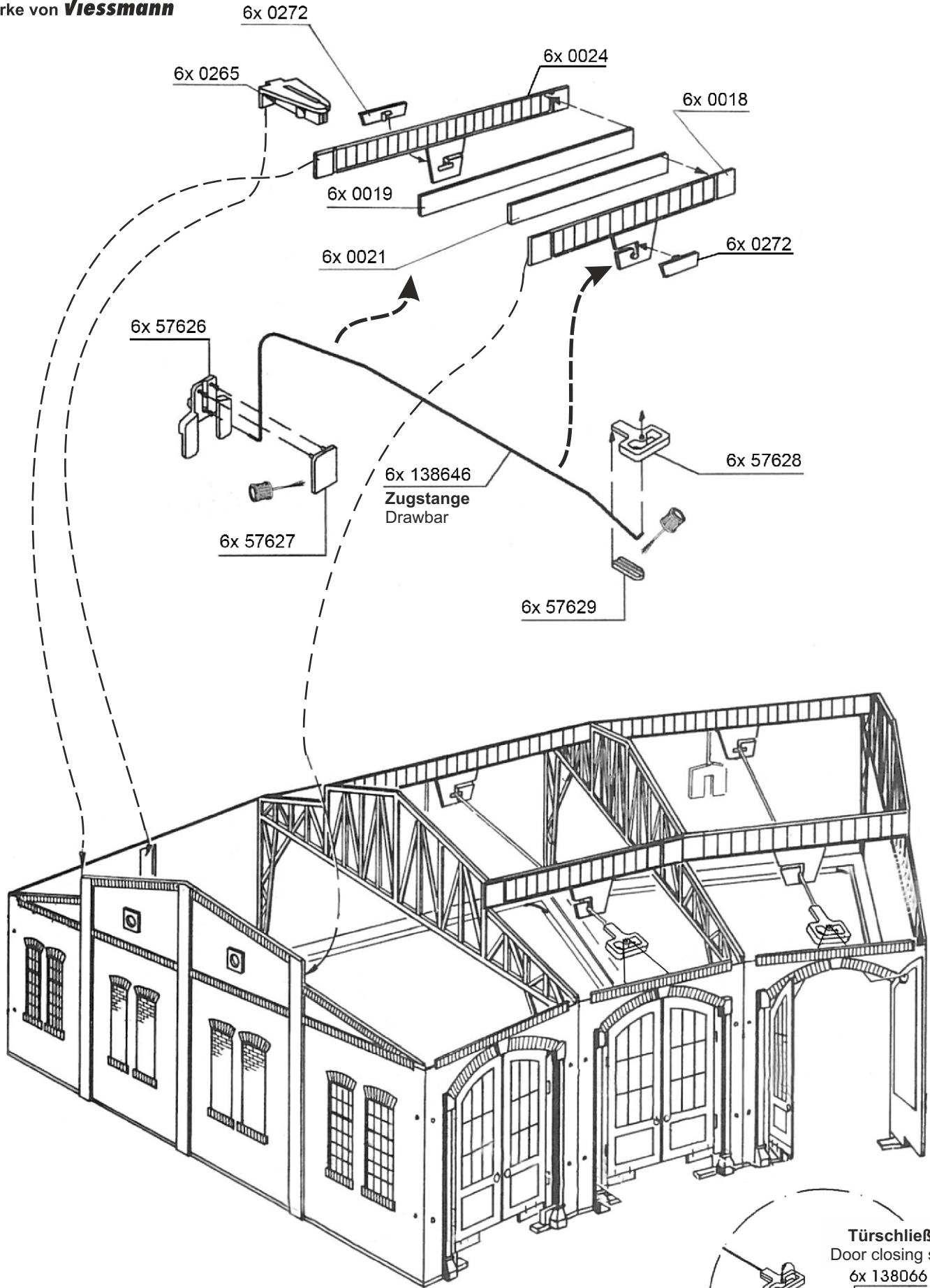

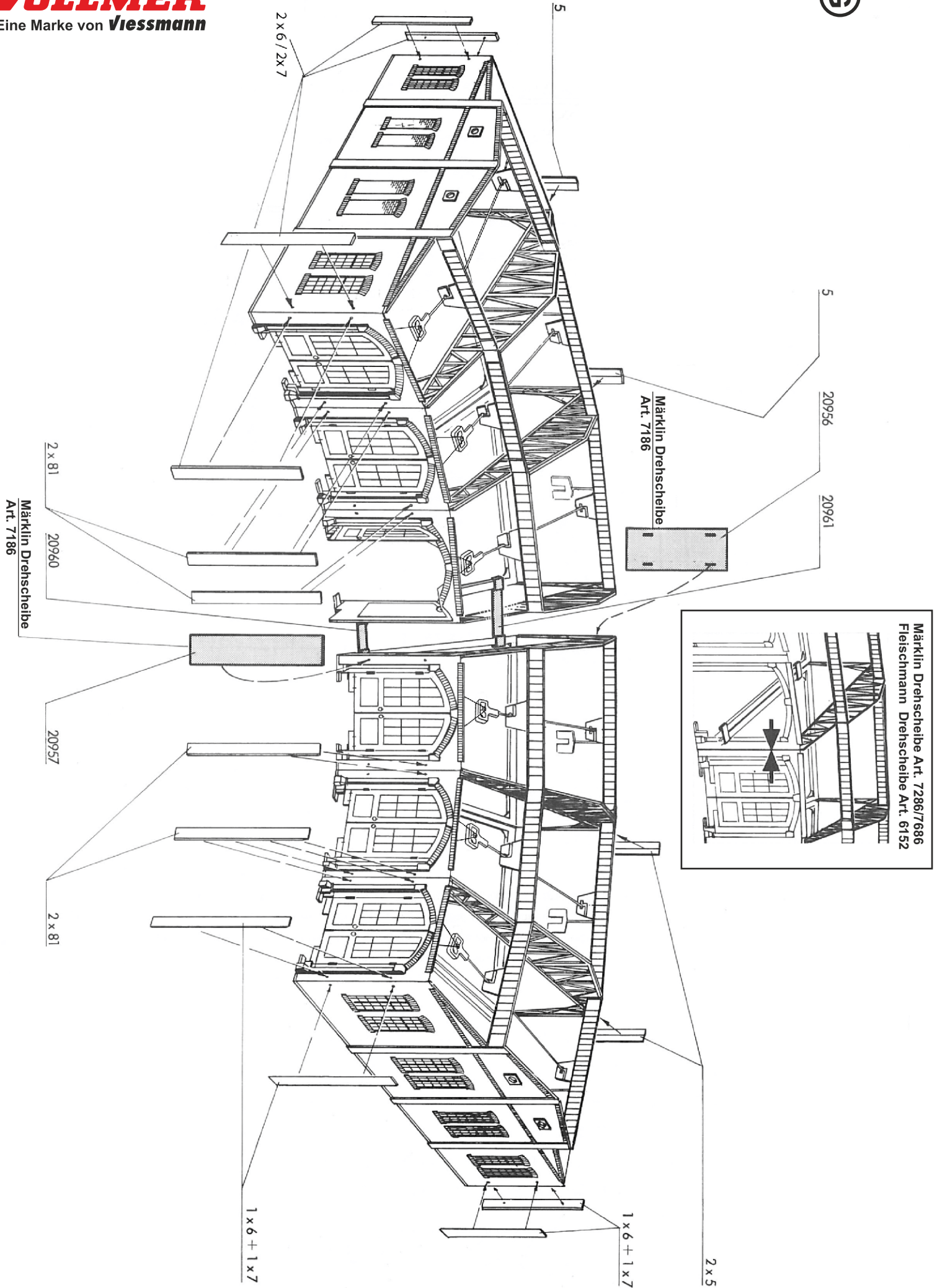

Märklin Drehscheibe Art. 7286/7686  
Fleischmann Drehscheibe Art. 6152



